

# HOLDER PAPER TOWEL HOLDER

MAKE YOUR LIFE SIMPLE

## Specifications

<b>Product Name</b>	Paper Towel Holder
<b>Model</b>	PDUZ77
<b>Applicable Place</b>	Kitchen
<b>Package List</b>	Paper Towel Holder x1, Long Screws x2, Short Screws x2, Expansion Screws x2, User Guide x1

The parameters above are derived from the laboratory of VICSEED. The actual parameters may differ from product to product or other factors. All images shown here are for reference only.

## Overview

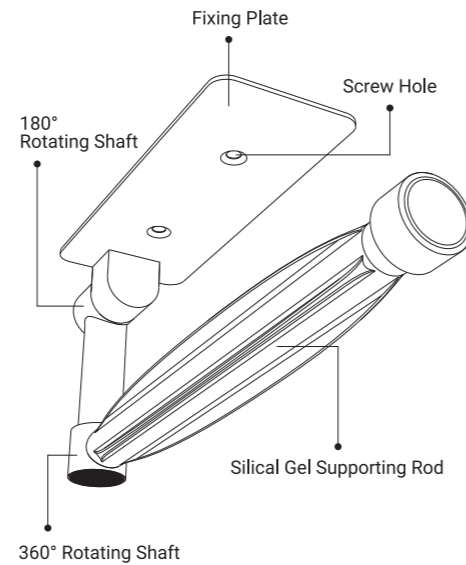

## Attentions Before Installation

- This paper towel holder has 2 installation methods:
  - Adhesive Fixation: it's suitable for smooth and flat surfaces, such as tile surfaces
  - Screw Fixation: it's suitable for irregular surfaces, such as uneven walls
 Please choose the corresponding method according to the type of surface for installation before you start to install the holder.
- In order to secure the fixed and adhesiving effect, the surface for installation of the paper towel holder must be cleaned up before installation.
- When fixing by adhesiving, it is need to keep pressing firmly the holder for 1 minute to make it fixed, and put it aside and wait for 24h for a maximum viscosity, after which time the paper towel is allowed to be put on it for use.
- When you choose the adhesive fixation and it is not stable enough, please use it together with the screws.

### Smooth Surface

Directly stick the holder by viscose glue to fix it (if you worry about instability, screws may also be nailed to fix it)

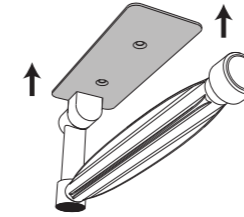

### Coarse Surface

First, stick the holder by viscose glue to fix it, then nail screws to fix it.

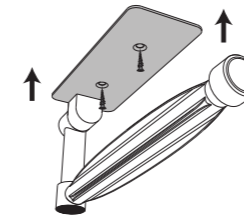

## Installation Instructions

### Method 1: Adhesive Fixation

- Clean up the surface for installation of the paper towel holder and keep it dry.

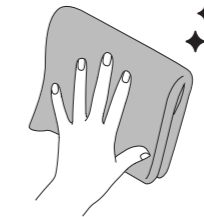

- Tear off the viscose release film at the bottom of the paper towel holder, stick the holder onto the cleaned region, and press firmly for 1 minute to fix it.

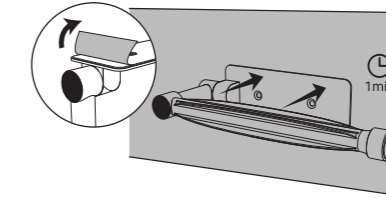

- Waiting for 24h later, rotate the rotating shaft to adjust the angle of the holder.

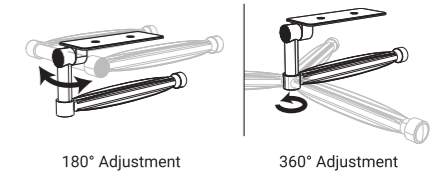

- Insert the paper towels then you can use it.

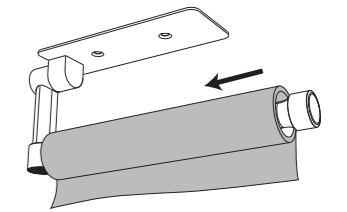

### Method 2: Screw Fixation

- Clean up the surface for installation of the paper towel holder and keep it dry.



- A: For the wall, use long screws to fix it.**
  - Put the holder close to the installation area, mark the position where the hole is aligned with the wall;
  - Use the tools to drill holes into the wall, and then insert the Expansion Screws in the holes;
  - Stick the holder on the wall according to the aligned hole, insert the long screw and fasten it to fix the holder.

**Note:**  
Pay attention to safety when using the tools.

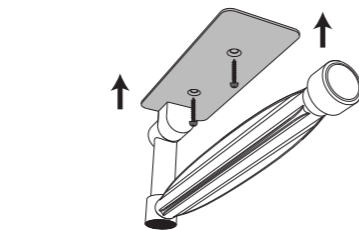
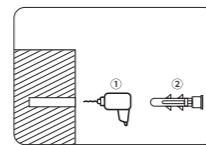

**B: For cabinets, use short screws to fix it.**  
Adhesive the holder on the cabinets, insert the screws, and you can directly tighten the screws with tools.

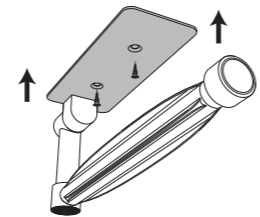

**Warm tips:** This step may be skipped in case of a smooth surface, while in case of a coarse surface, screws must be nailed to fix the holder.

- Rotate the rotating shaft to adjust the angle of the holder.

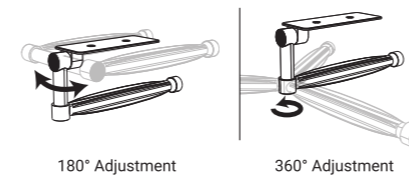

- Insert the paper towels then you can use it.

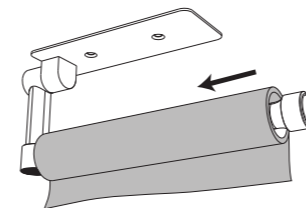

## Attentions

- The double rotating shaft design is specially applied in this product so as to bring more freedom to your using experience. You can adjust at will the supporting angle of paper shower holder by 180° or 360° according to your demand.
- In order to bring you a better using experience, a considerate design of silical gel supporting rod is applied in this product, which not only is suitable for matching rolls of paper towels in any size, but also furthermore can stabilize and fix rolls of paper towel, making it convenient for tearing the paper towel with single hand.
- When exchanging paper rolls, you just need to slide the empty paper rolls along the silical gel supporting rod to remove it and then install a new one, with no need to adjust the angle of rotating shaft once again.
- The maximum load capacity of this product is 11LB, so if you hang other items on the supporting rod, please don't hang too heavy items with it.
- This product is delivered with an auxiliary screw, please store it well for an exchange.
- When cleaning the paper towel holder, it would work well by wiping it with damp cloth and then making it dry.

## Customer Service

- 12-month limited warranty
- Lifetime technical support
- support@vicseed.com
- www.vicseed.com

Any question, please feel free to contact us. Fix issue within 24 hours.

SCAN THE CODE TO WATCH USING VIDEO



**SHENZHEN HOMGMI TECHNOLOGY CO., LTD.**

Add : RM1503, BLK C, Zhantao Technology BLDG, Minzhi Avenue, Minzhi ST, Longhua DIST, Shenzhen, China

Email : support@vicseed.com  
Web : www.vicseed.com

Shenzhen Homgmi Technology Co., Ltd. All Rights Reserved.

Made in China